

Llaves y Prefabricados Stopcocks and Unfinished Products

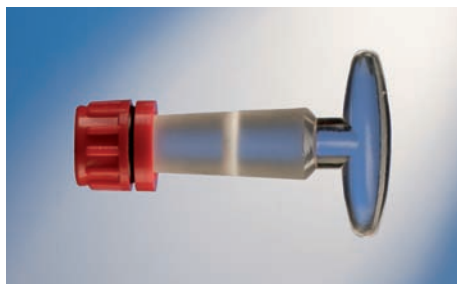

28 25 32



28 25 42

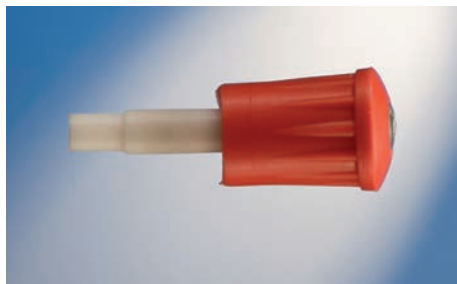

28 25 52



28 01



28 03



28 70

Machos para llaves, vidrio macizo

Glass key for stopcock

REFERENCIA CAT. NUMBER	Ø TALADRO BORE (MM.)	Ø MÁXIMO MACHO MAXIMUM KEY (MM.)
28 25 32	1,5	NS - 12,5
28 25 34	2,5	NS - 14,5
28 25 36	4	NS - 18,8

Machos para llaves, PTFE cónica

PTFE conical key for stopcock

REFERENCIA CAT. NUMBER	Ø TALADRO BORE (MM.)	Ø MÁXIMO MACHO MAXIMUM KEY (MM.)
28 25 42	2,5	NS - 12,5
28 25 44	4	NS - 14,5
28 25 46	6	NS - 18,8

Punzones para llaves, PTFE aguja Con regulación.

PTFE needle key for stopcock With regulation.

REFERENCIA CAT. NUMBER	LLAVE DE PASO KEY SIZE (MM.)
28 25 52	3
28 25 54	6
28 25 56	10

Llave paso recto, macho vidrio macizo

Stopcock, one way, solid glass key

REFERENCIA CAT. NUMBER	Ø TALADRO BORE (MM.)	Ø MÁXIMO MACHO MAXIMUM KEY (MM.)	Ø EXT. RAMAS SIDE ARMS (MM.)
28 01 01	1,5 - 2,5	NS - 12,5	8
28 01 03	2,5 - 4	NS - 14,5	10
28 01 05	4 - 6	NS - 18,8	12

Llaves de paso recto, macho PTFE cónico.

Stopcock, one way, solid glass key.

REFERENCIA CAT. NUMBER	Ø TALADRO BORE (MM.)	Ø MÁXIMO MACHO MAXIMUM KEY (MM.)	Ø EXT. RAMAS SIDE ARMS (MM.)
28 03 01	1,5 - 2,5	NS - 12,5	8
28 03 03	2,5 - 4	NS - 14,5	10
28 03 05	4 - 6	NS - 18,8	12

Llave de paso recto, PTFE aguja con regulación, ramas rectas.

Stopcock, one way, PTFE needle with regulation, straight arms.

REFERENCIA CAT. NUMBER	Ø PASO Ø BORE (MM.)	Ø EXT. RAMAS Ø ARMS (MM.)
28 70 04	3	8
28 70 06	6	10
28 70 10	10	13

Llave para bureta recta, macho vidrio

Stopcock, glass key, for burettes

REFERENCIA CAT. NUMBER	Ø RAMA Ø ARM (MM.)	Ø PASO Ø BORE (MM.)
28 72 08	8	3

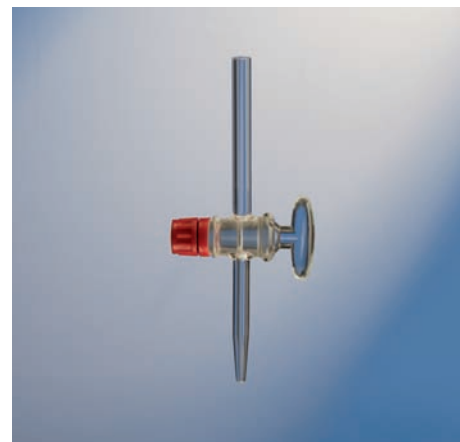

28 72 08

Llave para bureta recta, macho PTFE cónico

Stopcock, PTFE conical key, for buretes

REFERENCIA CAT. NUMBER	Ø RAMA Ø ARM (MM.)	Ø PASO Ø BORE (MM.)
28 72 10	8	3



28 72 10

Llave para bureta, PTFE aguja Con regulación.

Stopcock, PTFE needle key, for buretes With regulation.

REFERENCIA CAT. NUMBER	Ø RAMA Ø ARM (MM.)	Ø PASO Ø BORE (MM.)
28 72 04	8	3

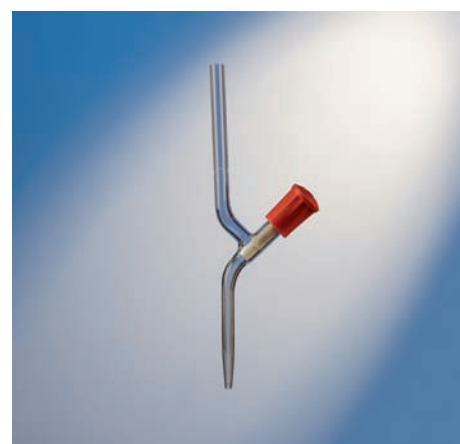

28 72

Llave para bureta, polipropileno

- Máxima precisión.
- No necesita lubricación.
- Regulación suave.
- Membrana cambiabile.
- Adaptable a tubos de Ø exterior 6 mm.

Stopcock, polypropylene key, for buretes

- Liquid tight fit.
- Without lubrication.
- Smooth regulation.
- Interchangeable membrane.
- Adaptable to 6 mm. OD tubes.

REFERENCIA CAT. NUMBER	DESCRIPCIÓN DESCRIPTION	Ø EXT. RAMAS OD ARMS (MM.)
47 90 00	Llave completa / Complete stopcock:	6
47 90 10	Llave PP/ PP Key	
47 90 20	Repuesto (membrana de vitón suelta) Spare part (VITON® membrane, only)	



47 90

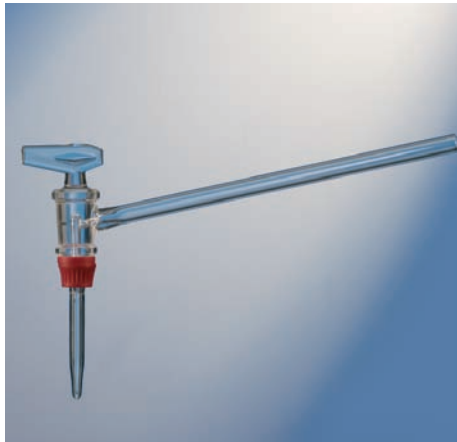

28 72 16

Llave para bureta lateral, macho vidrio

Stopcock, glass key, for burettes, lateral

REFERENCIA CAT. NUMBER	Ø RAMA Ø ARM (MM.)	Ø PASO Ø BORE (MM.)
28 72 16	8	3



28 72 26

Llave para bureta lateral, macho PTFE cónico

Stopcock, PTFE conical key, for buretes, lateral

REFERENCIA CAT. NUMBER	Ø RAMA Ø ARM (MM.)	Ø PASO Ø BORE (MM.)
28 72 26	8	3



28 72 36

Llave para bureta lateral, macho PTFE aguja

Stopcock, PTFE needle key, for buretes, lateral

REFERENCIA CAT. NUMBER	Ø RAMA Ø ARM (MM.)	Ø PASO Ø BORE (MM.)
28 72 36	8	3



28 71

Llave PTFE aguja, ramas a 90° Con regulación.

Stopcock, PTFE needle, one way, lateral 90° With regulation.

REFERENCIA CAT. NUMBER	Ø PASO Ø BORE (MM.)	Ø EXT. RAMAS Ø ARMS (MM.)
28 71 04	3	8
28 71 06	6	10
28 71 10	10	13

Llaves de 2 vias oblicuas, con macho de vidrio macizo

Stopcocks, two way, double oblique bore with solid glass key

REFERENCIA CAT. NUMBER	Ø TALADRO BORE (MM.)	Ø MÁXIMO MACHO MAXIMUM KEY (MM.)
28 19 01	2,5	NS - 14,5
28 19 02	4	NS - 18,8



28 19

Llaves de 2 vias oblicuas, con macho de vidrio hueco

Stopcocks, two way, double oblique bore with hollow glass key

REFERENCIA CAT. NUMBER	Ø TALADRO Ø BORE (MM.)	Ø MÁXIMO MAXIMUM Ø KEY (MM.)	Ø EXT. RAMAS Ø SIDEARMS (MM.)
28 18 02	2	NS - 24	9
28 18 03	3	NS - 29,2	9



28 18

Llaves de 2 vias oblicuas, con macho PTFE

Stopcocks, two way, double oblique bore with glass key

REFERENCIA CAT. NUMBER	Ø TALADRO BORE (MM.)	Ø MÁXIMO MACHO MAXIMUM KEY (MM.)
28 25 04	2,5	NS - 14,5
28 25 06	4	NS - 18,8
28 25 08	6	NS - 21,5



28 25

Llaves de 3 ramas en "T" a 90°, con macho de vidrio macizo

Para líquidos fríos.

Stopcocks, tree way, with solid glass T-bore key For cold liquids.

REFERENCIA CAT. NUMBER	Ø TALADRO BORE (MM.)	Ø MÁXIMO MACHO MAXIMUM KEY (MM.)	Ø EXT. RAMAS SIDE ARMS (MM.)
28 06 02	2	NS - 14,5	8



28 06 02

Llaves de 3 ramas en "T" a 90°, con macho de vidrio hueco

Para gases y líquidos calientes.

Stopcocks, tree way, with hollow glass T-bore key

For hot liquids and gases.

REFERENCIA CAT. NUMBER	Ø TALADRO BORE (MM.)	Ø MÁXIMO MACHO MAXIMUM KEY (MM.)	Ø EXT. RAMAS SIDE ARMS (MM.)
28 20 02	2	NS - 24	9
28 20 03	3	NS - 29,2	9



28 20

Llaves de 3 ramas en "T" a 90°, con macho PTFE cónico

Stopcocks, tree way, with PTFE conical key

REFERENCIA CAT. NUMBER	Ø TALADRO BORE (MM.)	Ø MÁXIMO MACHO MAXIMUM KEY (MM.)	Ø EXT. RAMAS SIDE ARMS (MM.)
28 06 12	2	NS - 14,5	8



28 06 12



27 03

Llaves de paso recto con salida rompe - vacío

Con macho de vidrio macizo. Para líquidos y gases fríos o poco calientes.

Stopcock, straight bore, device "break-vacuum"

Solid glass key. For use with cool and warm liquids and gases.

REFERENCIA CAT. NUMBER	Ø TALADRO BORE (MM.)	Ø MÁXIMO MACHO MAXIMUM KEY (MM.)	Ø OLIVAS Ø HOSE CONECTORS (MM.)
27 03 05	4	NS - 18,8	12 - 13



29 01

Llaves para vacío de paso recto Con macho hueco.

Stopcock, vacuum, one way, glass, straight bore With hollow key.

REFERENCIA CAT. NUMBER	Ø TALADRO Ø BORE (MM.)	Ø MÁX. MACHO MAXIMUM Ø KEY (MM.)	Ø EXT. RAMAS Ø SIDE ARMS (MM.)	LONGITUD RAMA LENGHT ARM (MM.)
29 01 02	2,5	NS - 14,5	9	90
29 01 03	3,5	NS - 18,8	10	90
29 01 05	5	NS - 24	12	90
29 01 07	7	NS - 29,2	14	100



29 02

Llaves para vacío de tres ramas en "T" Con macho hueco.

Stopcock, vacuum, three ways, T-type With hollow key.

REFERENCIA CAT. NUMBER	Ø TALADRO Ø BORE (MM.)	Ø MÁX. MACHO MAXIMUM Ø KEY (MM.)	Ø EXT. RAMAS Ø SIDE ARMS (MM.)	LONGITUD RAMA LENGHT ARM (MM.)
29 02 03	3,5	NS - 24	10	90
29 02 05	5	NS - 29,2	12	100



27 36

Llaves para vacío en "T"

Con unión esmerilada de vidrio hueco aptas para el paso de líquidos y gases calientes.

Stopcock, vacuum, T-type

With hollow-glass joint suitable for hot liquids and gases.

REFERENCIA CAT. NUMBER	ESMERILADO JOINT
27 36 44	29 / 32

Llaves para alto vacío rectas

Tres zonas de cierre con juntas tóricas de vitón, regulación fina, punzón PTFE.

Stopcock, high vacuum, straight

Three viton o-rings, fine regulation, PTFE spindle.

REFERENCIA CAT. NUMBER	Ø RAMA SIDE ARM (MM.)	PASO BORE (MM.)
28 73 06	10 x 100	6
28 73 10	13 x 100	10



28 73

Llaves para alto vacío 90º

Tres zonas de cierre con juntas tóricas de VITON®, regulación fina, punzón PTFE.

Stopcock, high vacuum 90º

Three VITON® o-rings, fine regulation, PTFE spindle.

REFERENCIA CAT. NUMBER	Ø RAMA SIDE ARM (MM.)	PASO BORE (MM.)
28 75 06	10 x 100	6
28 75 10	13 x 100	10



28 75

Llaves para alto vacío de 3 vías

Tres zonas de cierre con juntas tóricas de vitón, regulación fina, punzón PTFE.

Stopcock, high vacuum, three ways

Three closing areas with viton toric joints, fine regulation, PTFE spindle.

REFERENCIA CAT. NUMBER	Ø RAMA SIDE ARM (MM.)	PASO BORE (MM.)
28 74 06	10 x 100	6
28 74 10	13 x 100	10

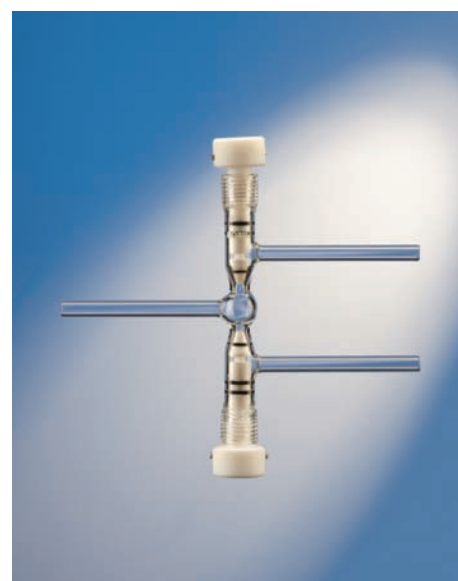

28 74

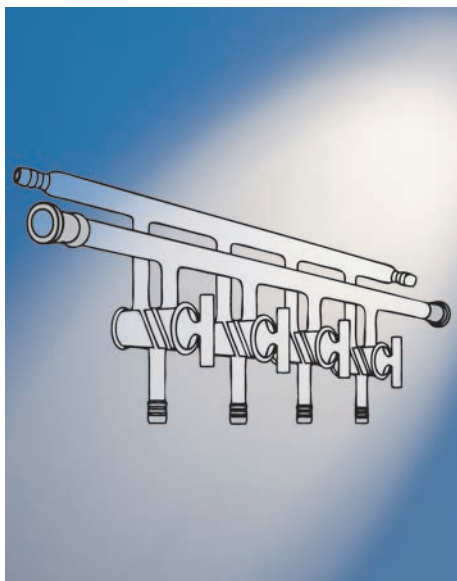

29 03

Línea de vacío

Con doble vía y cuatro llaves de vidrio macho hueco.*

Vacuum manifold Double way and four glass hollow keys stopcocks.*

REFERENCIA CAT. NUMBER	ESMERILADO JOINT
29 03 80	14 / 23

* Bajo demanda se pueden fabricar con llaves de PTFE.

* On request, we can manufacture with PTFE stopcocks.



25 69

Tubos para conexiones múltiples

Con llaves de vidrio. Separación entre olivas 60 mm.

Manifold

With glass stopcock. Distance between hose connectors 60 mm.

REFERENCIA CAT. NUMBER	Nº SALIDAS CON LLAVE NUMBER OF OUTLETS
25 69 13	3
25 69 14	4
25 69 15	5
25 69 16	6



25 68

Tubos para conexiones múltiples

Manifold

- Con llaves de regulación fina en PTFE, oliva principal 14 - 15 mm Ø.
- Olivas secundarias 10 - 11 mm Ø.
- Separación entre olivas 60 mm.

- With needle PTFE stopcock, principal hose connector Ø 14-15 mm
- Secondary hose connector Ø 10-11 mm.
- Distance between hose connectors 60 mm.

REFERENCIA CAT. NUMBER	Nº SALIDAS CON LLAVE NUMBER OF OUTLETS
25 68 40	4
25 68 50	5
25 68 60	6

Válvula de cierre Por flotación de obturador.

Vacuum float valve Float valve

REFERENCIA CAT. NUMBER	CARACTERÍSTICAS FEATURES
33 87 00	Olivas con 10 - 11 mm Ø / Hose connectors Ø 10-11 mm



33 87

Válvula de cierre Con obturador relleno de mercurio.

Vacuum float valve Filled with mercury.

REFERENCIA CAT. NUMBER	CARACTERÍSTICAS FEATURES
33 89 00	Olivas con 10 - 11 mm Ø / Hose connectors Ø 10-11 mm



33 89

Válvulas simples con grifo

Sistema de fijación por bayoneta. Tubería flexible. PTFE.

General purpose valves

Straight through bayonet. Flexible pipe. PTFE.

REFERENCIA CAT. NUMBER	Ø OLIVA ARM Ø (MM.)	PASO BORE (MM.)
VSGP 0452	4,5	2
VSGP 0602	6	2
VSGP 0803	8	3
VSGP 1004	10	4

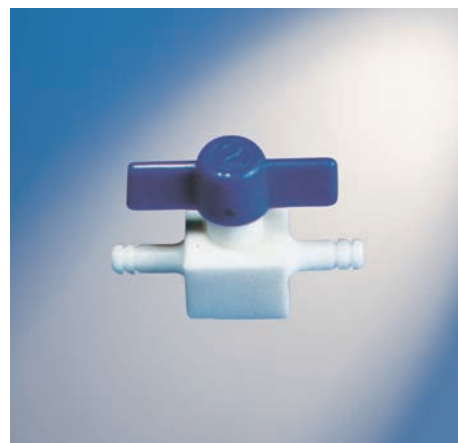

VSGP

Válvulas en T con grifo Sistema de fijación por bayoneta. Tubería flexible.

Debido a sus características hacen posible cualquier tipo de montaje con resistencia a altas temperaturas químico-inerte. PTFE.

General purpose valves T-type bayonet. Flexible pipe. It is possible any type of assembly with resistance to high temperatures chemistry-inert. PTFE.

REFERENCIA CAT. NUMBER	Ø OLIVA ARM Ø (MM.)	PASO BORE (MM.)
VSGT 0452	4,5	2
VSGT 0602	6	2
VSGT 0803	8	3
VSGT 1004	10	4



VSGT



10 01 23



10 01 13



CSEP



CSEM

Uniones cónicas esmeriladas intercambiables hembra

Ground joint, outer part only, interchangeable

REFERENCIA CAT. NUMBER	ESMERILADO JOINT	Ø EXTERIOR DEL TUBO OD (MM.)
10 01 30	5 / 13	8
10 01 29	7 / 16	10
10 01 19	10 / 19	13
10 01 20	12 / 21	15
10 01 21	14 / 23	17
10 01 22	19 / 26	22
10 01 23	24 / 29	28
10 01 24	29 / 32	34
10 01 25	34 / 35	40
10 01 27	45 / 40	50
10 01 28	60 / 46	65

Uniones cónicas esmeriladas intercambiables macho

Ground joint, inner part only, interchangeable

REFERENCIA CAT. NUMBER	ESMERILADO JOINT	Ø EXTERIOR DEL TUBO OD (MM.)
10 01 03	5 / 13	4
10 01 05	7 / 16	6
10 01 07	10 / 19	8
10 01 09	12 / 21	11
10 01 11	14 / 23	13
10 01 12	19 / 26	17
10 01 13	24 / 29	22
10 01 14	29 / 32	26
10 01 15	34 / 35	32
10 01 17	45 / 40	42
10 01 18	60 / 46	54

Clips para sujeción de uniones cónicas esmeriladas POM.

Joint clip for conical joint POM.

REFERENCIA CAT. NUMBER	PARA UNIÓN CÓNICA FOR JOINT	COLOR COLOUR
CSEP 1019	10 / 19	Negro / Black
CSEP 1423	14 / 23	Amarillo / Yellow
CSEP 1926	19 / 26	Azul / Blue
CSEP 2429	24 / 29	Verde / Green
CSEP 2932	29 / 32	Rojo / Red
CSEP 3435	34 / 35	Naranja / Orange
CSEP 4540	45 / 40	Marrón / Brown

Clips para sujeción de uniones cónicas esmeriladas

Fabricados en metal cromado.

Clips for grinding unions

Made of chromed metal.

REFERENCIA CAT. NUMBER	PARA UNIÓN CÓNICA FOR JOINT
CSEM 1019	10 / 19
CSEM 1221	12 / 21
CSEM 1423	14 / 23
CSEM 1926	19 / 26
CSEM 2429	24 / 29
CSEM 2932	29 / 32
CSEM 4540	45 / 40

Uniones rótulas esmeriladas intercambiables hembra

Spherical joints, cup

REFERENCIA CAT. NUMBER	ESMERILADO JOINT
10 02 20	S-13
10 02 21	S-19
10 02 22	S-29
10 02 23	S-35
10 02 25	S-51
10 02 26	S-64



10 02 2

Uniones rótulas esmeriladas intercambiables macho

Spherical joints, ball

REFERENCIA CAT. NUMBER	ESMERILADO JOINT
10 02 10	S-13
10 02 11	S-19
10 02 12	S-29
10 02 13	S-35
10 02 15	S-51
10 02 16	S-64



10 02 1

Juntas para rótulas pulidas (silicona + PTFE)

Sealing rings for polished spherical joints (silicone + PTFE)

REFERENCIA CAT. NUMBER	PARA RÓTULA FOR SPHERICAL JOINT
JUNR 0113	NS 13
JUNR 0119	NS 19
JUNR 0129	NS 29
JUNR 0135	NS 35
JUNR 0141	NS 41
JUNR 0164	NS 64

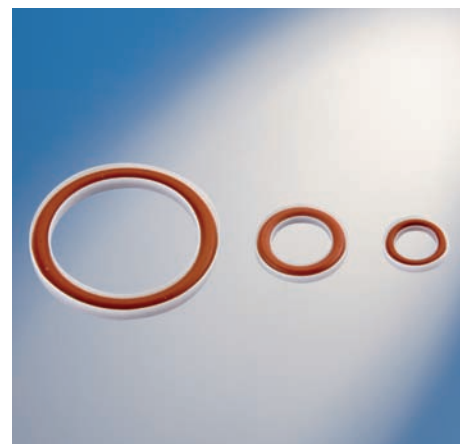

JUNR

Uniones roscadas SVS Para la unión flexible de dos tubos de vidrio

provistos de rosca con junta de silicona (VMQ) - PTFE integrada estable hasta 200 °C.

Threaded joints SVS Flexible union of two glass threads with built-in silicone washer (VMQ) - PTFE, stable up to 200 °C

REFERENCIA CAT. NUMBER	DOBLE ROSCA BEND IT THREADS
UNRO 0014	2 x GL 14
UNRO 0018	2 x GL 18
UNRO 0025	2 x GL 25
UNRO 0032	2 x GL 32



UNRO



PVSG

Probetas sin graduar

En vidrio borosilicato, pie hexagonal.

Cylinders without graduation Borosilicate glass, hexagonal base.

REFERENCIA CAT. NUMBER	CAPACIDAD CAPACITY (ML.)
PVSG 0005	5
PVSG 0010	10
PVSG 0025	25
PVSG 0050	50
PVSG 0100	100
PVSG 0250	250
PVSG 0500	500
PVSG 1000	1.000
PVSG 2000	2.000



MSAF

Matraces sin aforar

En vidrio borosilicato.

Volumetric flask without mark Borosilicate glass

REFERENCIA CAT. NUMBER	CAPACIDAD CAPACITY (ML.)	BOCA INNER JOINT
MSAF 0005	5	7 / 16
MSAF 0010	10	10 / 19
MSAF 0011	10	12 / 21
MSAF 0025	25	10 / 19
MSAF 0026	25	12 / 21
MSAF 0050	50	12 / 21
MSAF 0100	100	12 / 21
MSAF 0101	100	14 / 23
MSAF 0200	200	14 / 23
MSAF 0201	200	19 / 26
MSAF 0250	250	14 / 23
MSAF 0251	250	19 / 26
MSAF 0500	500	19 / 26
MSAF 1000	1.000	24 / 29
MSAF 2000	2.000	29 / 32



98 09

Grasa para llaves y uniones

Grease for keys and joints

REFERENCIA CAT. NUMBER	ENVASE BOTTLE
98 09 01	30 gr.